

ROOM AIR CONDITIONER

OUTDOOR UNIT

INSTALLATION INSTRUCTIONS

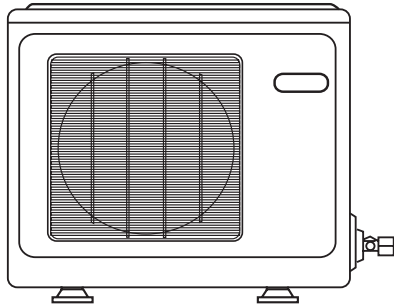

HCFU-18CF03 HCFU-18HF03

CONTENTS

Name of Parts-----	1
Safety Cautions-----	2-3
Installation Procedure-----	4-12

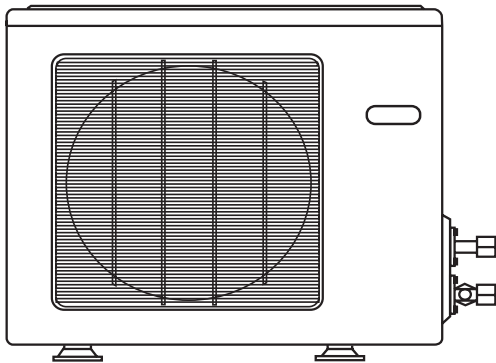

HCFU-28CF03 HCFU-28HF03

No.0010577563

- Before using the air conditioner, please read this manual carefully.
- Please keep this manual properly for future use.

Name of Parts

HCFU-18CF03 HCFU-18HF03

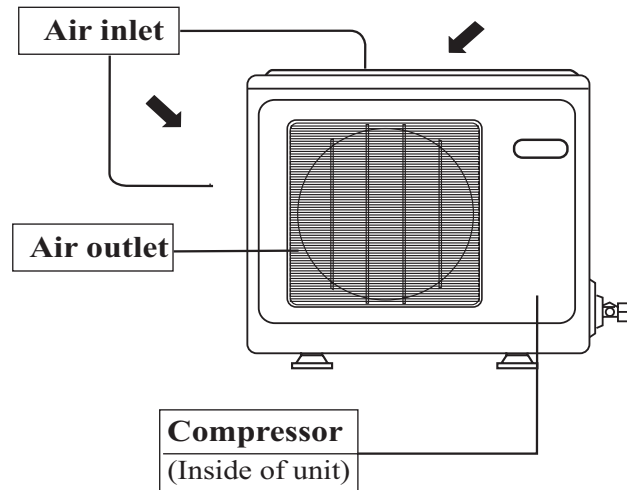

HCFU-28CF03 HCFU-28HF03

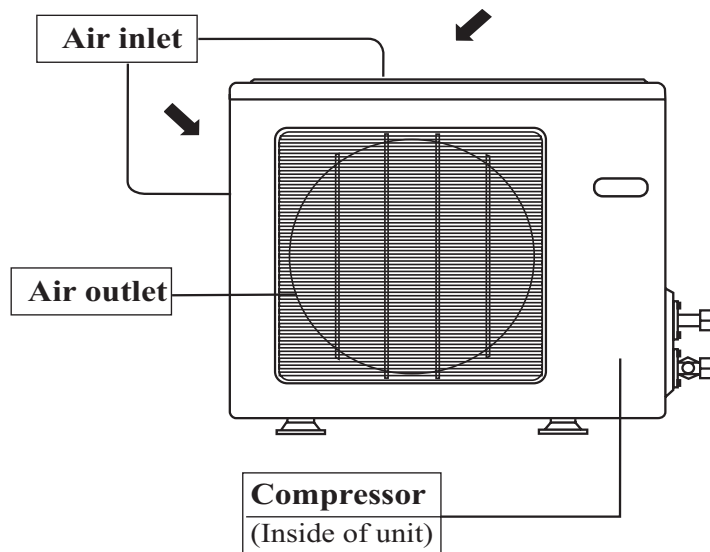

Safety Cautions

Carefully read the following information in order to operate the airconditioner correctly.

Below are listed three kinds of Safety Cautions and Suggestions.

WARNING! Incorrect operations may result in severe consequences of death or serious injuries.

CAUTION! Incorrect operations may result in injuries or machine damages; in some cases may cause serious consequences.

INSTRUCTIONS: These information can ensure the correct operation of the machine.

Be sure to conform with the following important Safety Cautions.

The Safety Cautions should be at hand so that they can be checked at any time when needed.

If the conditioner is transferred to the new user, this manual should be as well transferred to the new user.

WARNING!

- **If any abnormal phenomena is found (e. g. smell of firing), please cut off the power supply immediately, and contact the dealer to find out the handling method.**

In such case, to continue using the conditioner will damage the conditioner, and may cause electrical shock or fire hazard.



- **After a long time use of air-conditioner the base should be checked for any damages.**

If the damaged base is not repaired, the unit may fall down and cause accidents.



- **Don't dismantle the outlet of the outdoor unit.**

The exposure of fan is very dangerous which may harm human beings.



- **When need maintenance and repairment, call dealer to handle it.**

Incorrect maintenance and repairment may cause water leak, electrical shock and fire hazard.

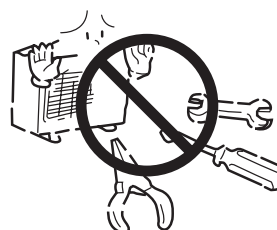

Safety Cautions

WARNING!

- **Installed electrical-leaking circuit breaker.**

It easily cause electrical shock without circuit breaker.

- **Air-conditioner can't be installed in the environment with inflammable gases because the inflammable gases near to air-conditioner may cause fire hazard.**

- **Please let the dealer be responsible for installing the conditioner.**

Incorrect installation may cause water leak, electrical shock and fire hazard.

- **Call the dealer to take measures to prevent the refrigerant from leaking.**

If conditioner is installed in a small room be sure to take every measure in order to prevent suffocation accident even in case of refrigerant leakage.

- **When conditioner is deinstalled or reinstalled dealer should be responsible for them.**

Incorrect installation may cause water leaking, electrical shock and fire hazard.

- **Connect earthing wire.**

Earthing wire should not be connected to the gas pipe, water pipe, lightning rod or phone line, incorrect earthing may cause shock.



Earthing

- **No goods or nobody is permitted to placed on or stand on outdoor unit.**

The falling of goods and people may cause accidents.



- **Don't operate the air-conditioner with damp hands.**

Otherwise will be shocked.



- **Only use correctly-typed fuse.**

May not use wire or any other materials replacing fuse, otherwise may cause faults or fire accidents.



- **Use discharge pipe correctly to ensure efficient discharge.**

Incorrect pipe use may cause water leaking.

1. Accessories

"Edging" for protection of electric wires from an opening edge.

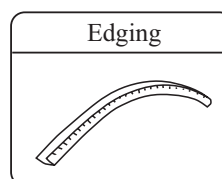

2. Selection of the place of installation

Select the place of installation satisfying the following conditions and, at the same time, obtain a consent from the client or user.

- Place where air circulates.
- Place free from heat radiation from other heat sources.
- Place where drain water may be discharged.
- Place where noise and hot air may not disturb the neighborhood.
- Place where there is not heavy snowfall in the winter time.
- Place where obstacles do not exist near the air inlet and air outlet .
- Place where the air outlet may not be exposed to a strong wind.
- Place surrounded at four sides are not suitable for installation. A 1m or more of overhead space is needed for the unit.
- Mount guide-louvers to place where short-circuit is a possibility.
- When installing several units, secure sufficient suction space to avoid short circuiting.

(1) Open space requirement around the unit

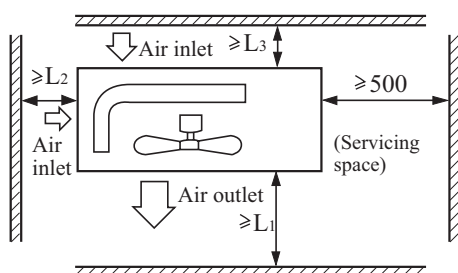

Note :

- (1). Fix the parts with screws
- (2). Don't intake the strong wind directly to the outlet air-flow hole.
- (3). A one meter distance should be kept from the unit top
- (4). Don't block the surroundings of the unit with sundries

Unit: mm

Case	I	II	III
Distance L ₁	open	open	500
L ₂	300	0	open
L ₃	150	300	150

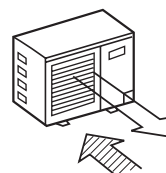

Wind direction



(2) Installation where the area with strong winds.

Install the unit so that the air outlet section of the unit must NOT be faced toward wind direction.

3. Installation of outdoor unit

(1) Installation

Fix the unit in a proper way according to the condition of a place where it is installed by referring to the following .

(a) Concrete foundation

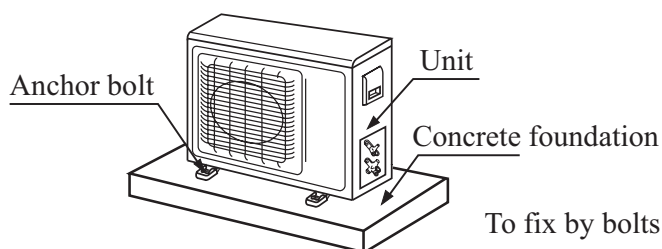

(b) Foundation anchor

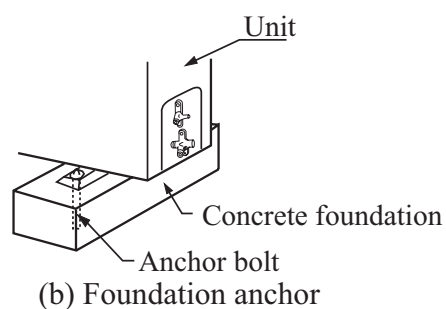

Note: (1) Give enough room for the concrete foundation to fix by anchor bolts.

Note: (1) Place the concrete foundation deep enough.

- Install the unit so that the angle of inclination must be less than 3 degrees.

(2) Installation sketch of outdoor unit

HCFU-18CF03 HCFU-18HF03

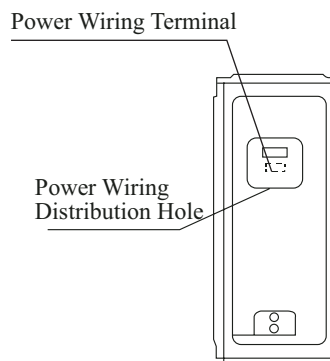
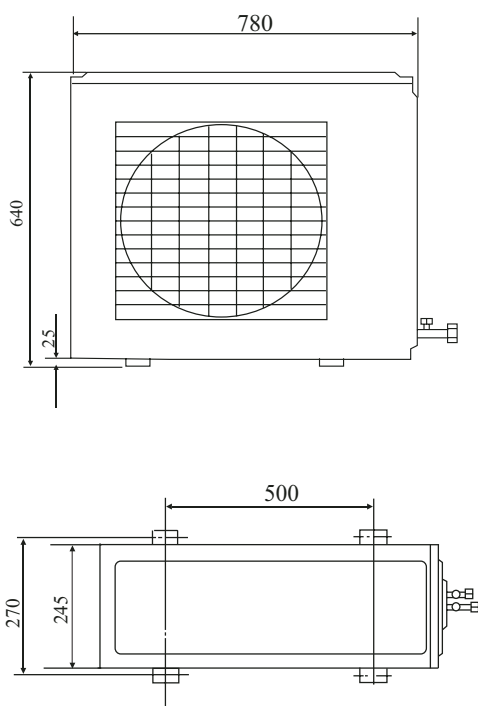

Installation Procedure

Installation of outdoor unit

HCFU-28CF03 HCFU-28HF03

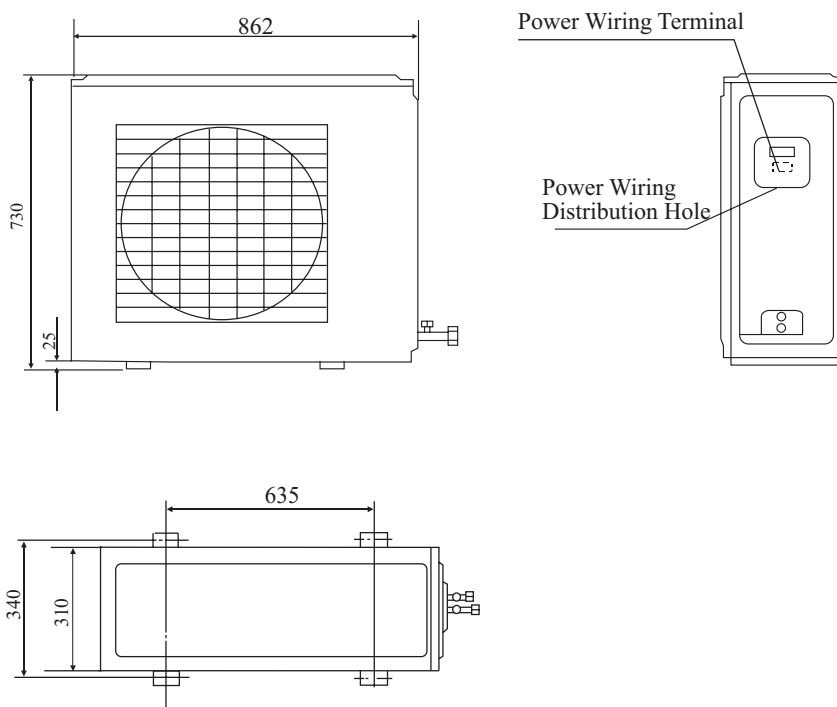

4. Refrigerant piping

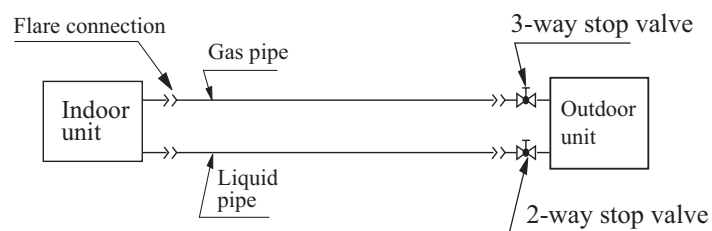

Installation Procedure

Refrigerant piping

(2) Piping size

HCFU-18CF03	Liquid pipe	Φ 6.35x0.8mm
HCFU-18HF03	Gas pipe	Φ 12.7x1.0mm
HCFU-28CF03	Liquid pipe	Φ 9.52x0.8mm
HCFU-28HF03	Gas pipe	Φ 15.88x1.0mm

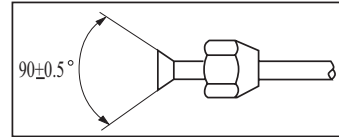

- Install the removed flare nuts to the pipes to be connected, then flare the pipes.

(3) Limitations for one way piping length and vertical height difference.

Model	One way piping length	Vertical height difference (between indoor and outdoor)
HCFU-18CF03 HCFU-18HF03	less than 15 m	less than 5 m
HCFU-28CF03 HCFU-28HF03	less than 30 m	less than 20 m

Precautions for refrigerant piping

- Do not twist or crush piping.
- Be sure that no dust is mixed in piping.
- Bend piping with as wide angle as possible.
- Keep insulating both gas and liquid piping.
- Check flare-connected area for gas leakage.

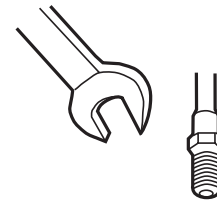

(4) Piping connection

- Connecting method (indoor unit)
Apply refrigerant oil at half union as large and flare nut.
To bend a pipe, give the roundness as possible not to crush the pipe.
When connecting pipe, hold the pipe centre to centre then screw nut on by hand, refer to Fig.
Be careful not to let foreign matters, such as sands enter the pipe.



Forced fastening without centering may damage the threads and cause a gas leakage.

Pipe dia	Fastening torque
Liquid pipe 6.35mm	14.2-17.2N·m
Liquid pipe 9.52mm	32.7-39.9N·m
Gas pipe 12.7mm	49.5-60.3N·m
Gas pipe 15.88mm	61.8-75.4N·m
Gas pipe 19.05mm	97.2-118.6N·m

Installation Procedure

Refrigerant piping

5. Air discharging method

After finishing connection of refrigerant pipe, it shall perform air tightness test.

- The air tightness test adopts nitrogen tank to give pressure according to the pipe connection mode as the following figure shown.

The gas and liquid valve are all in close state. In order to prevent the nitrogen entering the circulation system of outdoor unit, tighten the valve rod before giving pressure (both gas and liquid valve rods).

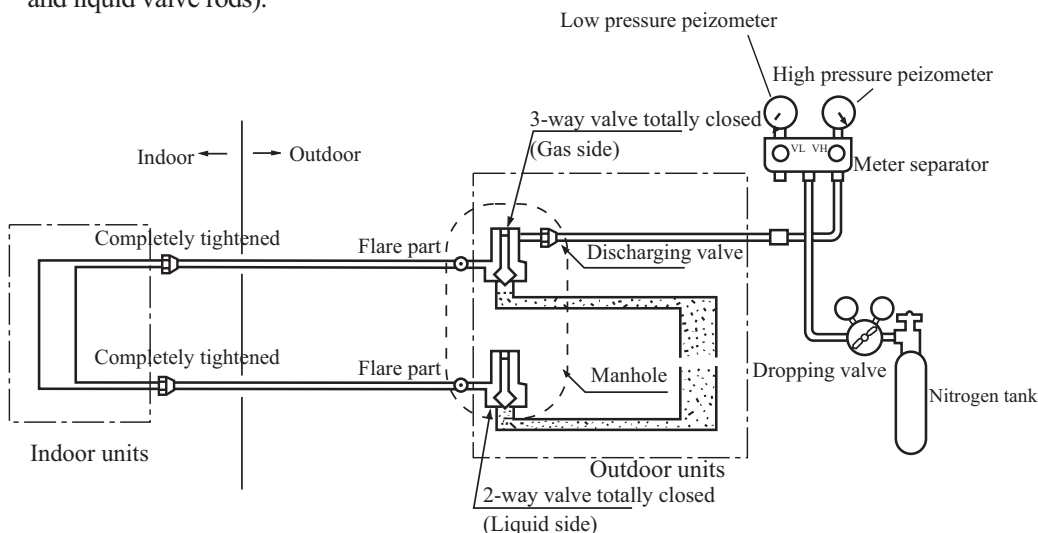

First step: 0.3MPa (3.0kg/cm²g) pressurize over 3 minutes.

Second step: 1.5Mpa (15kg/cm²g) pressurize over 3 minutes. Large leakage will be found.

Third step: 3.0 MPa (30kg/cm²g) pressurize about 24 hours. Little leakage will be found.

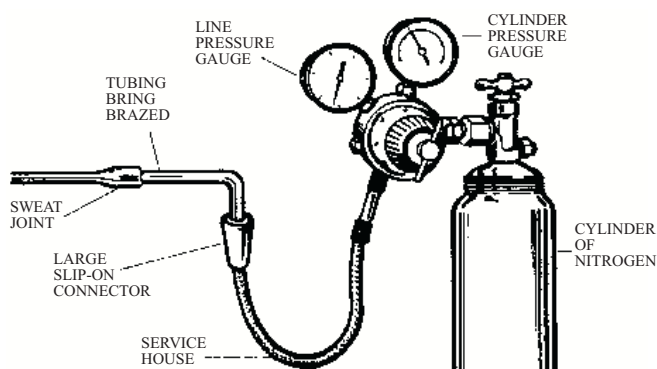

- Check if the pressure drops

The pressure does not drop-passed

The pressure drops-check the leaking point.

From pressurizing to 24 hours later, each 1 • difference of ambient temperature will make 0.01MPa(0.1kg/cm²g) pressure change. It shall be corrected during test.

Checking the leaking point

- In the first to third test steps, if the pressure drops, check the leakage in each joint use sense of hearing, feeling and soap water, etc. methods to find the leaking point. After confirming the leaking point, welding it again or tighten the nut tightly again.

Installation Procedure

Refrigerant piping

6. Piping and indoor unit vacuumizing

- Use vacuum pump to perform vacuumizing. It is strictly forbidden to use the refrigerant to remove the air inside the system.
- After air tightness test and discharging all the nitrogen, connect the vacuum pump as the following figure shown.

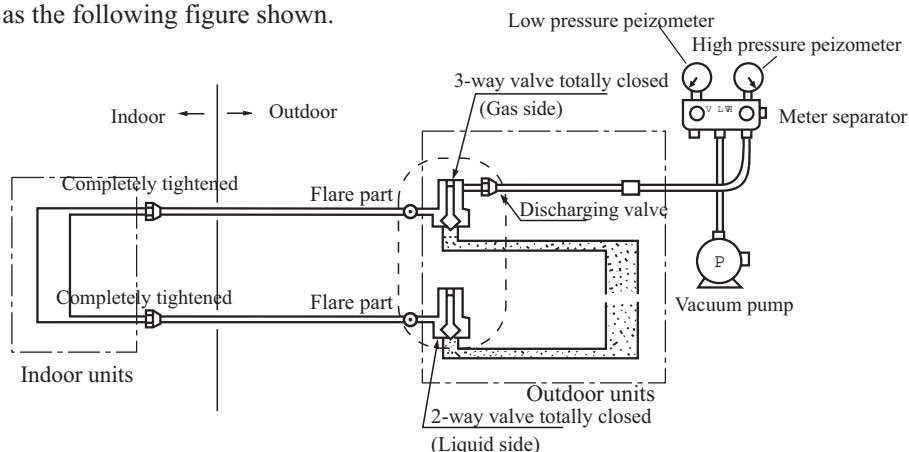

- It shall use the vacuum pump of (lower than -755mmHg)high vacuum degree and large air discharging (over 40l/min).
- The vacuumizing time depends on the length of the connecting pipe, generally is 1~2 hours. When vacuumizing, it shall be confirmed both gas and liquid side valves are closed.
- If after 2 hours vacuumizing, it cannot reach the vacuum degree below -755mmHg, it can be vacuumized for other 1 hour.
If after 3 hours vacuumizing, it still cannot reach the vacuum degree below -755mmHg, check if there is any leaking point and repair the them.
- If after over 2 hours vacuumizing, the vacuum degree is below -755mmHg, close the VL and VH on the meter separator and stop vacuumizing. 1 hour later to confirm if the vacuum degree changes. If changes, it indicates there is leaking point in the system. Check the leaking point and repair.
- After finishing the above vacuumizing, change the vacuum pump into refrigerant pump to charge the refrigerant.

7. Charging amount of refrigerant

When the total length (L) of the two units' connecting pipe is less than 5m, it is unnecessary to charge additional refrigerant.

If the connecting pipe (L) exceeds 5m, it shall charge Mg additional refrigerant per meter.

That is: Refrigerant charging amount = (L-5) x M (g)

For HCFU-18CF03 HCFU-18HF03 M=30,

For HCFU-28CF03 HCFU-28HF03 M=65

Only in COOLING operation can charge the additional refrigerant.

When charging, the refrigerant shall be charged from the charging nozzle of low pressure vavle.

- Be carefull when charging refrigerant, do not let the air mix into the system,and must charge the
- additional refrigerant in liquid condition.
-

5. Electric wiring

⚠ WARNING

DANGER OF BODILY INJURY OR DEATH
TURN OFF ELECTRIC POWER AT CIRCUIT BREAKER OR POWER SOURCE BEFORE MAKING ANY ELECTRIC CONNECTIONS.
GROUND CONNECTIONS MUST BE COMPLETED BEFORE MAKING LINE VOLTAGE CONNECTIONS.

(1) Selection of size of power supply and interconnecting wires.

Precautions for Electric wiring

- Electric wiring work should be conducted only by authorized personnel.
- Do not connect more than three wires to the terminal block. Always use round type crimped terminal lugs with insulated grip on the ends of the wires.
- Use copper conductor only.

Select wire sizes and circuit protection from table below. (This table shows 20 m length wires with less than 2% voltage drop.)

Item Model	Phase	Circuit breaker		Power source wire size (minimum)	Earth leakage breaker	
		Switch breaker (A)	Overcurrent protector rated capacity (A)		Switch breaker	Leak current
HCFU-18CF03 HCFU-18HF03	1	30	20	2.5mm ²	30	30mA
HCFU-28CF03 HCFU-28HF03	1	40	36	4.0mm ²	40	30mA

(2) Wiring connection

For HCFU-28CF03 HCFU-28HF03, make wiring to supply power to the outdoor unit, so that the power for the indoor unit is supplied by terminals.

For HCFU-18CF03 HCFU-18HF03, make wiring to supply power to the indoor unit, so that power for the outdoor unit is supplied by terminals.

For the detailed wiring connection with the indoor units, see the corresponding indoor operation and instruction manual.

HCFU-18CF03

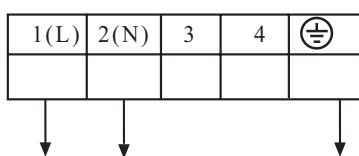

1PH,220-230V~,50Hz

To Indoor Unit

FIG.1

HCFU-18HF03

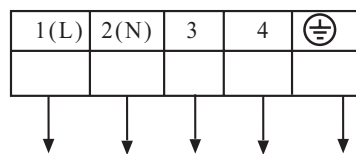

1PH,220-230V~,50Hz

To Indoor Unit

FIG.2

HCFU-28CF03

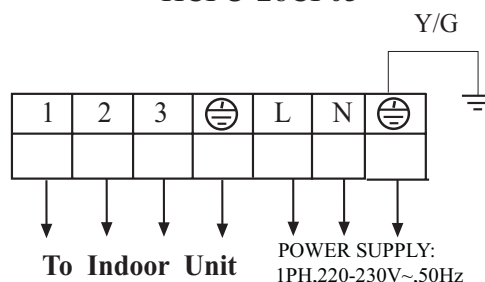

FIG.3

HCFU-28HF03

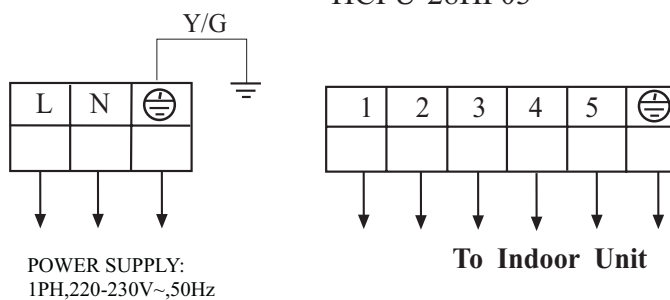

FIG.4

⚠ WARNING

INTERCONNECTING WIRES MUST BE WIRED ACCORDING TO FIG.1
FIG.2 FIG.3.FIG.4.INCORRECT WIRING CAUSE EQUIPMENT DAMAGE.

(3) Wiring procedure

- 1) Remove set screws on the side before taking off the front panel toward the direction shown in figure.
- 2) Connect wires to the terminal block correctly and fix the wires with a wire clamp equipped nearby the terminal block.
- 3) Route the wires in a proper way and penetrate the wires through the opening for electric wiring on the side panel.

6. Test run

⚠ CAUTION

THIS UNIT WILL BE STARTED INSTANTLY WITHOUT "ON" OPERATION WHEN ELECTRIC POWER IS SUPPLIED.BE SURE TO EXECUTE "OFF" OPERATION BEFORE ELECTRIC POWER IS DISCONNECTED FOR SERVICING.

- This unit has a function of automatic restart system after recovering power stoppage.

(1) Test run

Run the unit continuously for about 30 minutes, and check the following.

- Suction pressure at check joint of service valve for gas pipe.
- Discharge pressure at check joint on the compressor discharge pipe.
- Temperature difference between return air and supply air for indoor unit.